

APRICITY 3D
ARCHITECTURAL
RENDERING

September 3, 2025
Hartman Kitchen

WALL 1

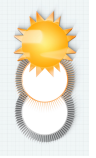
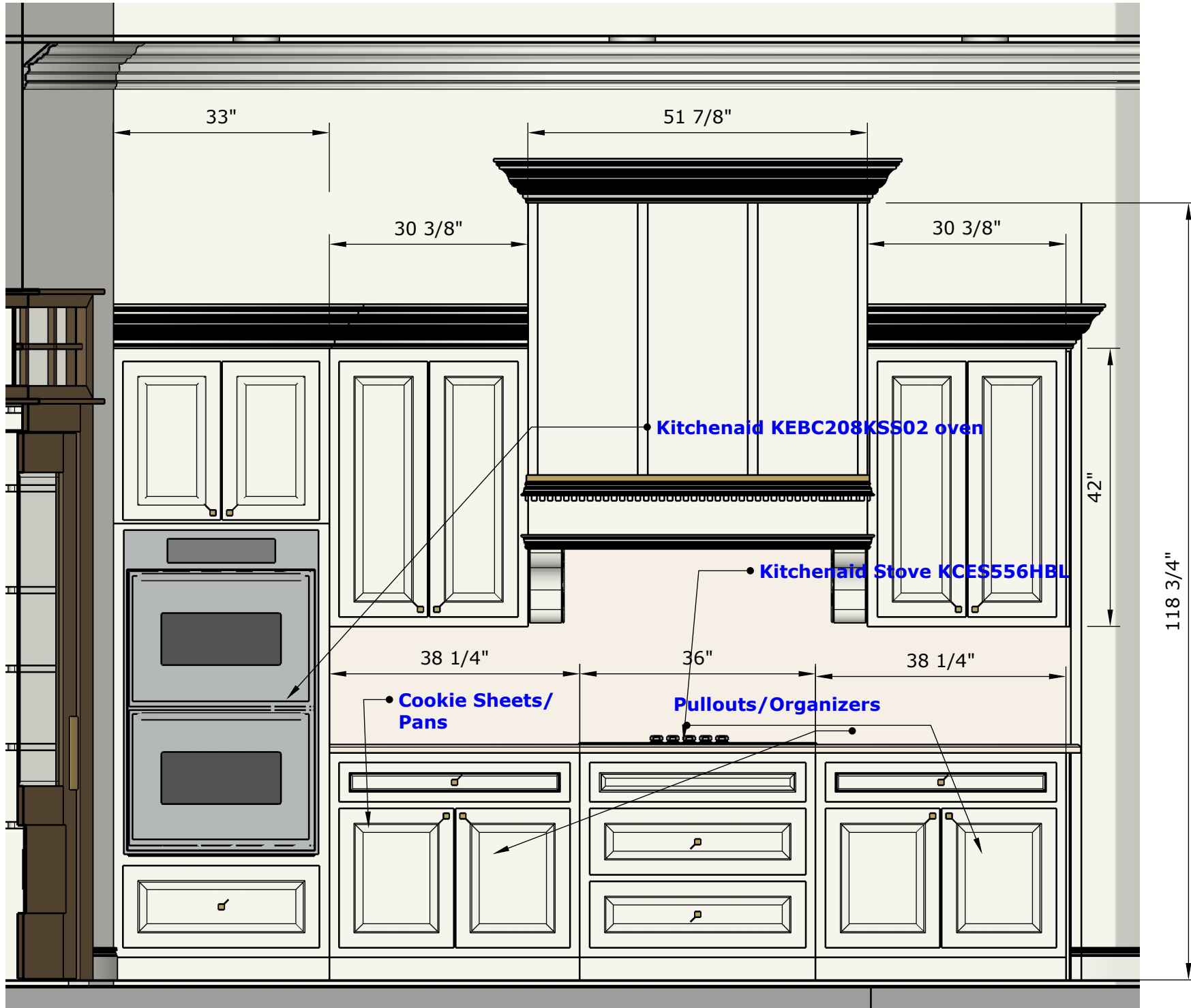

APRICITY 3D
ARCHITECTURAL
RENDERING

September 3, 2025
Hartman Kitchen

WALL 5

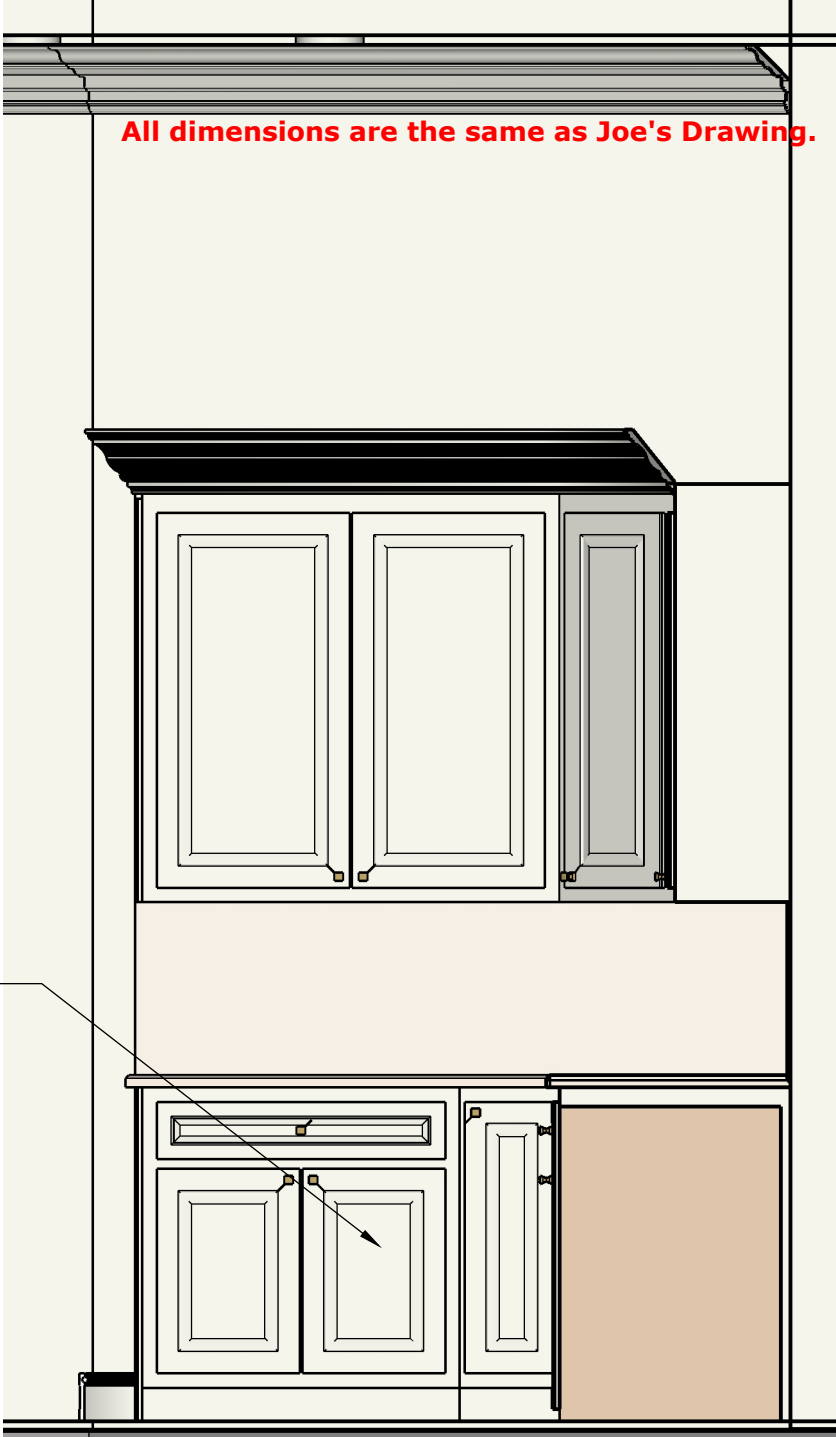

All dimensions are the same as Joe's Drawing.

Pullouts

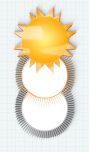

APRICITY 3D
ARCHITECTURAL
RENDERING

September 3, 2025
Hartman Kitchen

WALL 6

All dimensions are the same as Joe's Drawing.

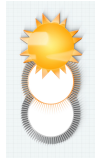
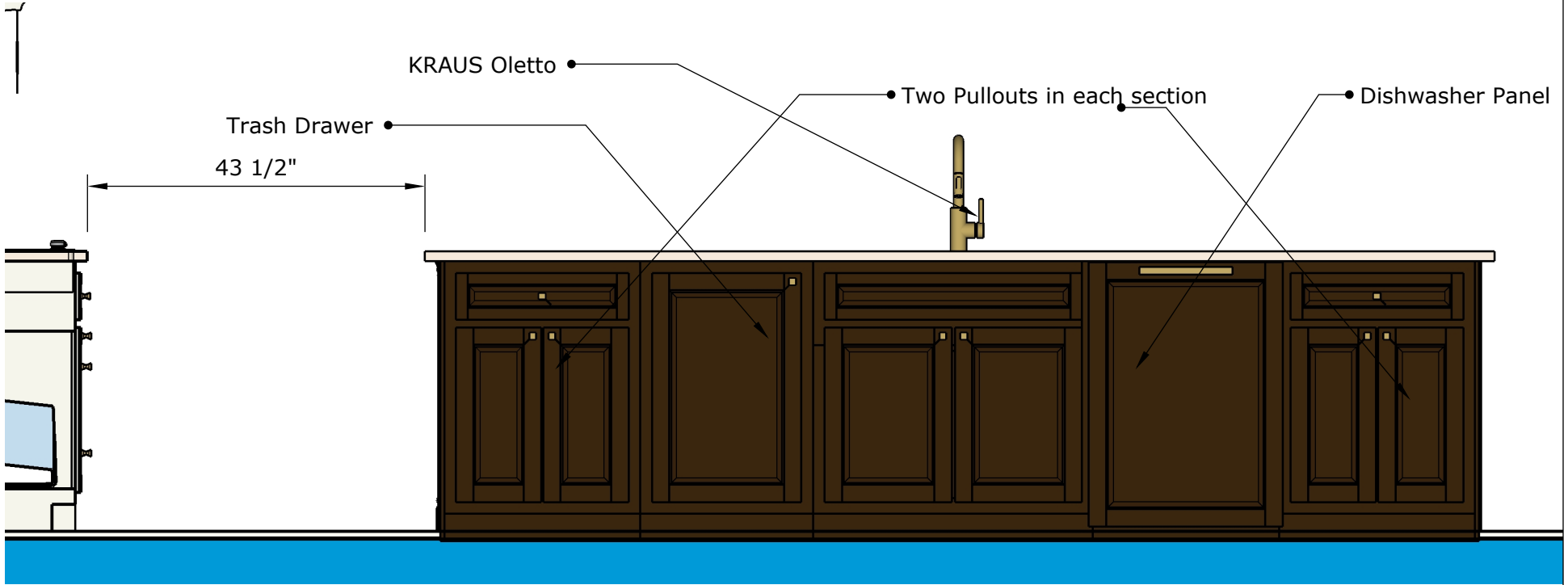

APRICITY 3D
ARCHITECTURAL
RENDERING

September 3, 2025
Hartman Kitchen

ISLAND FRONT

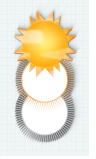

APRICITY 3D
ARCHITECTURAL
RENDERING

September 3, 2025
Hartman Kitchen

ISLAND SIDE

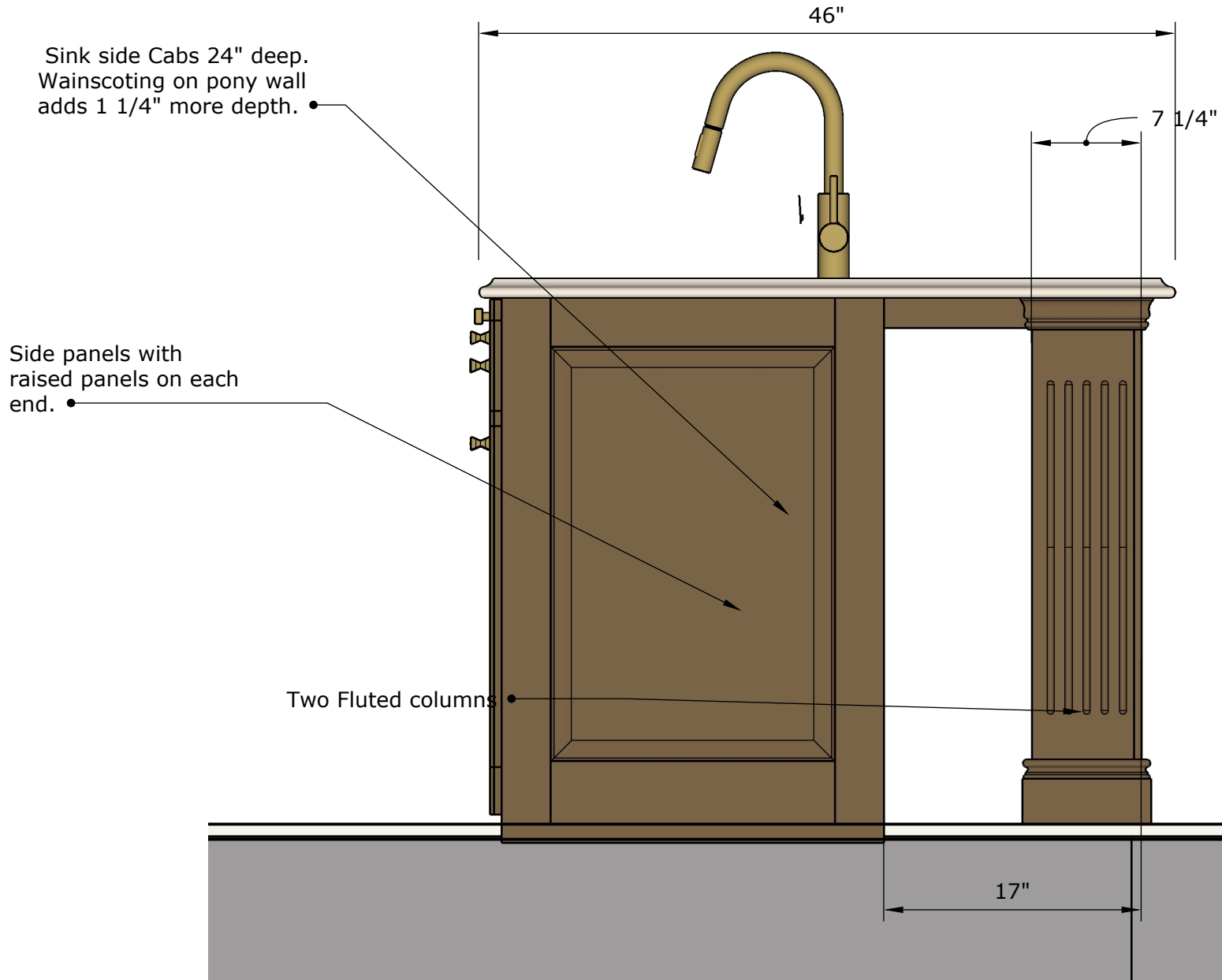

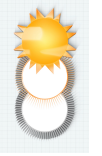
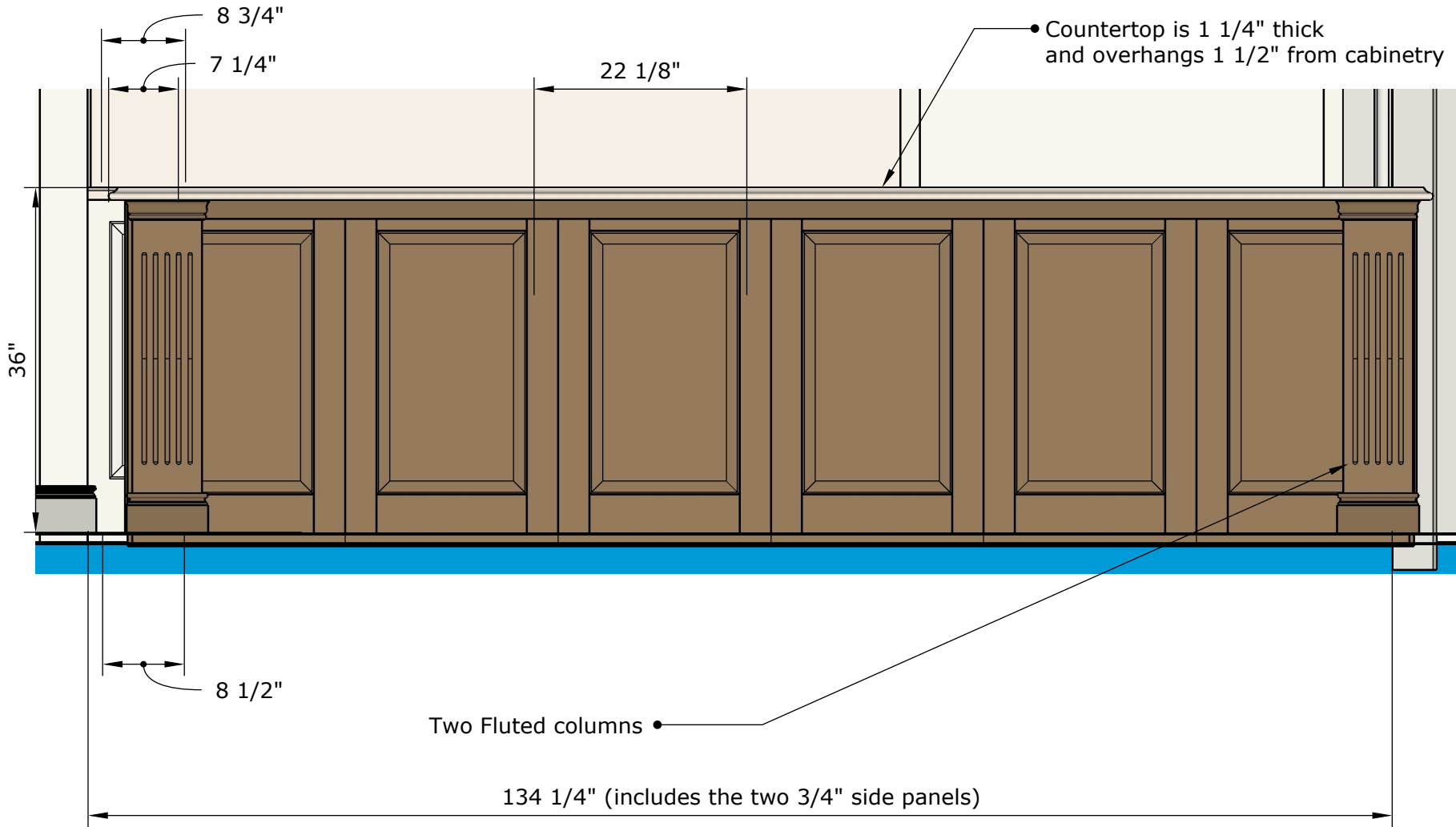

APRICITY 3D
ARCHITECTURAL
RENDERING

August 30, 2025
Hartman Kitchen

ISLAND BACK

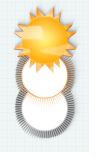
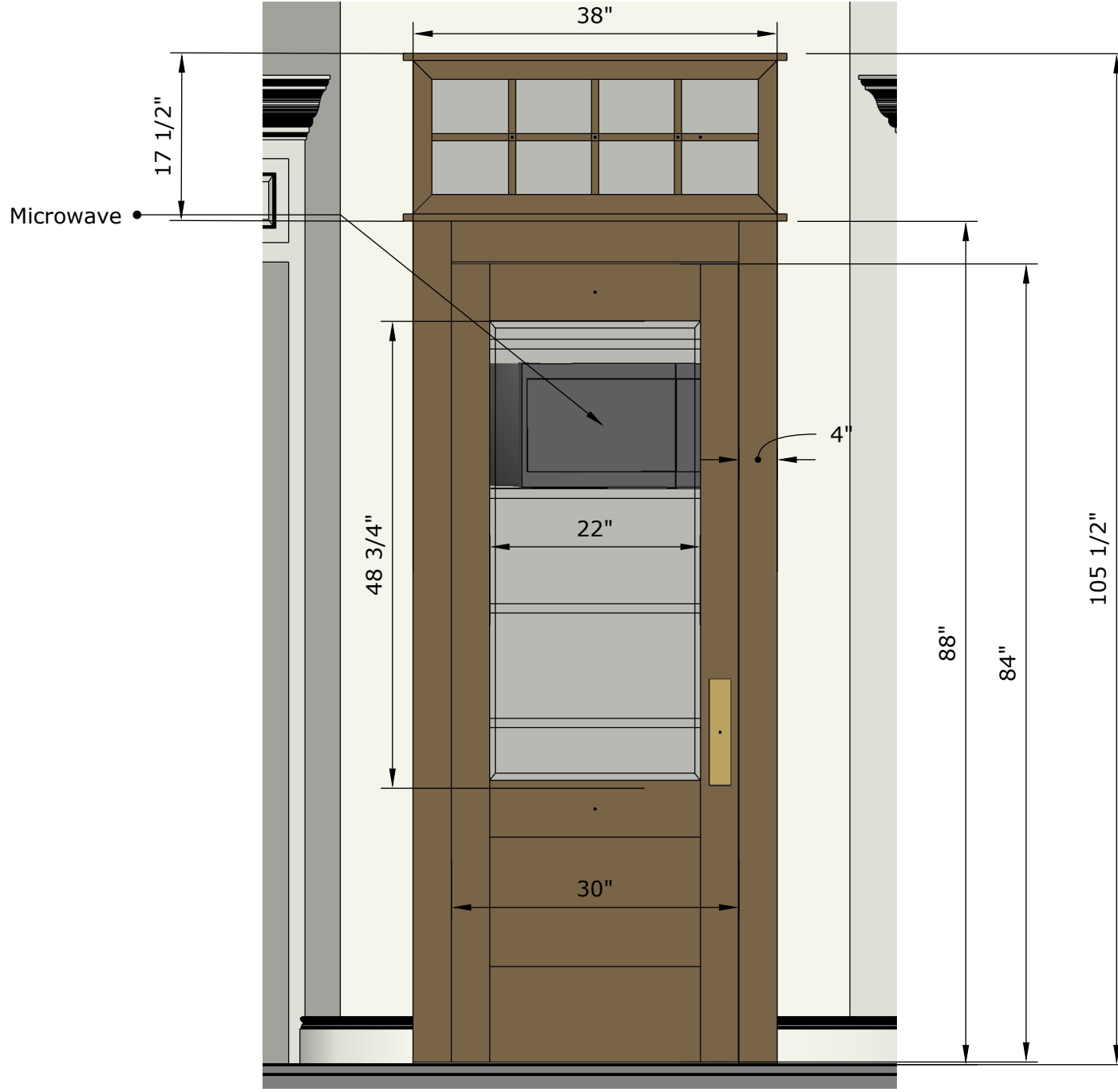

APRICITY 3D
ARCHITECTURAL
RENDERING

September 3, 2025
Hartman Kitchen

PANTRY DOOR

3.6 deg angle

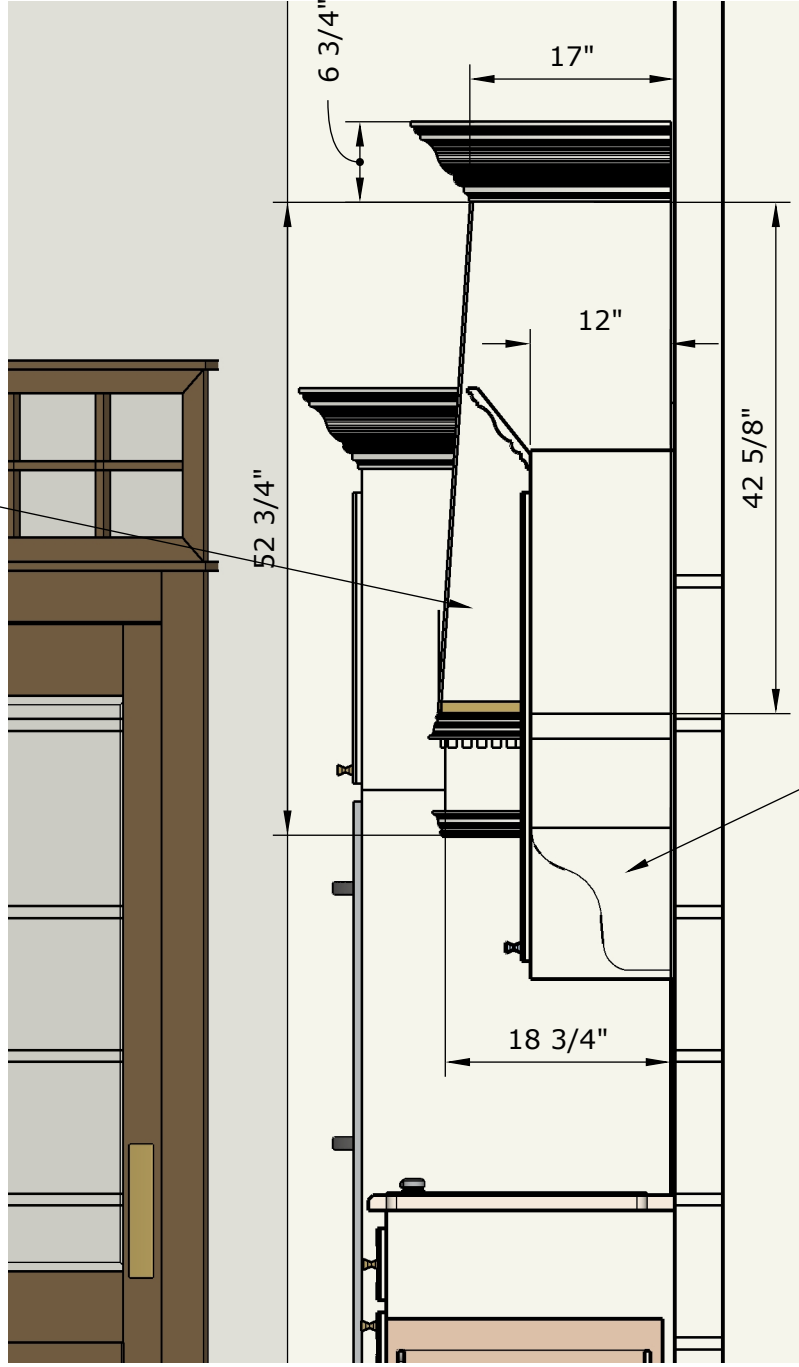

Osbourne 80881 Corbel

HOOD CROSS
SECTION

September 3, 2025
Hartman Kitchen

APRICITY 3D
ARCHITECTURAL
RENDERING

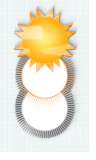

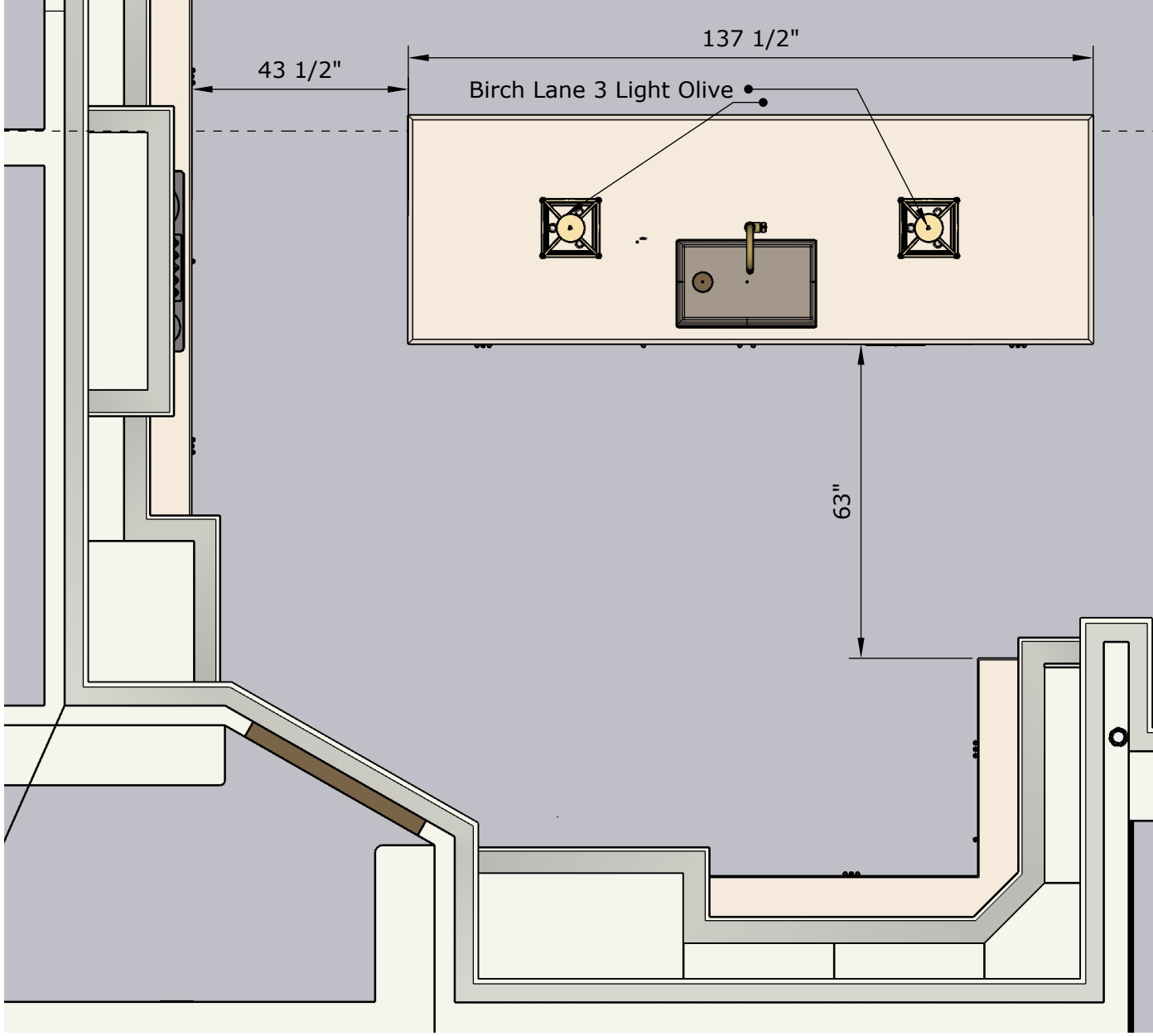

AERIAL

September 3, 2025
Hartman Kitchen

APRICITY 3D
ARCHITECTURAL
RENDERING

